



Pallet Racking

We have a variety of pallet racking systems that will provide the perfect storage solution for your business.

We take full consideration that each business needs to find a storage solution which makes the most of the available space.

We will evaluate the type of goods you store, the amount of floor space available for the racking installation, the speed of throughput and the type of equipment you use before recommending the best solution.

-
- ★ **Adjustable pallet racking**
 - ★ **Push back pallet racking**
 - ★ **Pallet live racking**
 - ★ **External pallet racking**
 - ★ **Narrow aisle pallet racking**
 - ★ **Drive-In pallet racking**

The fully flexible warehouse solution



Heights

Height (mm)
2500, 3000,
4000, 5000, 6000



Widths

Widths (mm)
1350, 2225, 2700, 3300



Depths

Depths (mm)
900, 1100



Application

Environment
Warehouse

Usage
**Multipurpose Storage,
Heavy & Bulky Items,**



Construction

Frames: **Steel**
Galvanised

Beams: **Steel**
RAL 1003 Yellow

*Please contact the Sales Team
for accessory construction details*



Loadings

Beam UDL (per pair)
Up to 3790kg

Choose your pallet and frame size

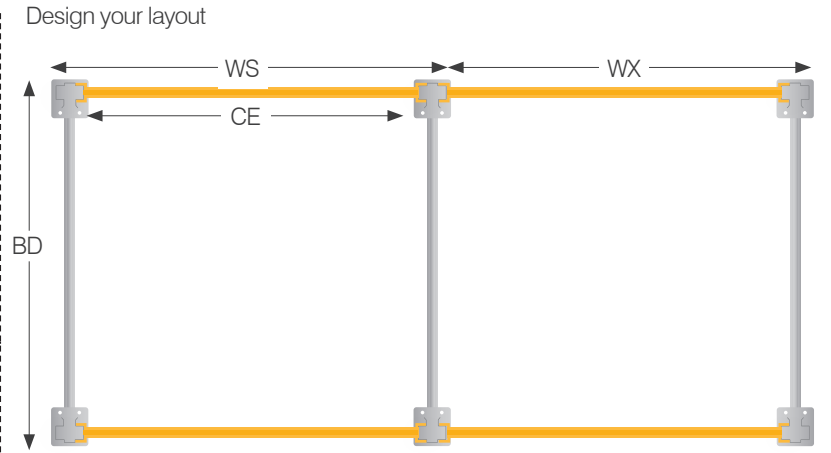
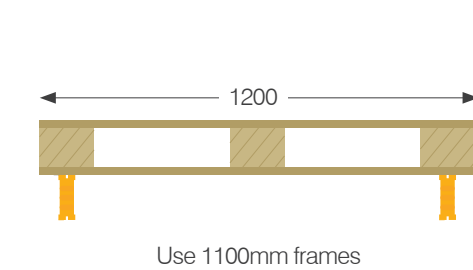
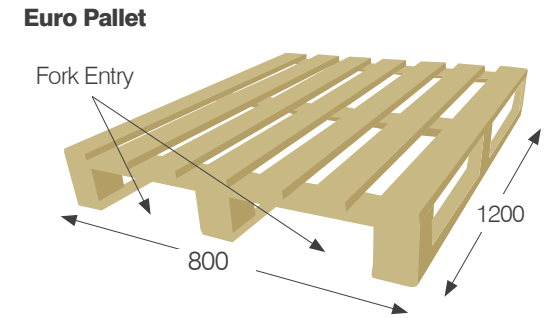
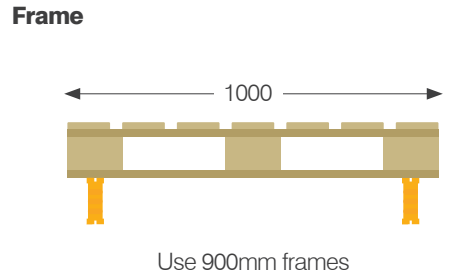
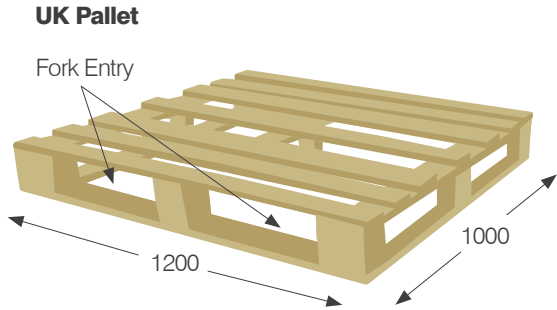

Nominal Depth (D)	BD Bay Depth	Nominal Width (W)	CE Clear Entry	WS Starter Bay	WX Extension Bay
900mm	920mm	1350mm	1313mm	1555mm	1456mm
1100mm	1120mm	2225mm	2183mm	2425mm	2326mm
		2700mm	2663mm	2905mm	2806mm
		3300mm	3263mm	3505mm	3406mm

Baseplate allowance for frame depth = 15mm, Baseplate allowance for entire row length = 31mm

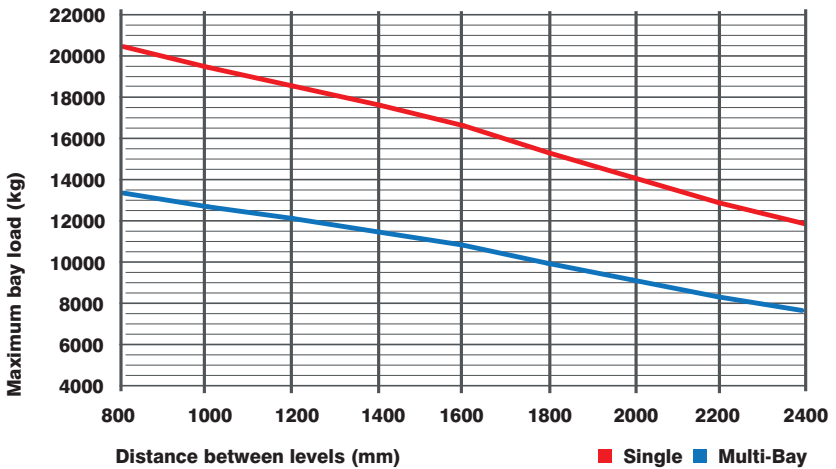
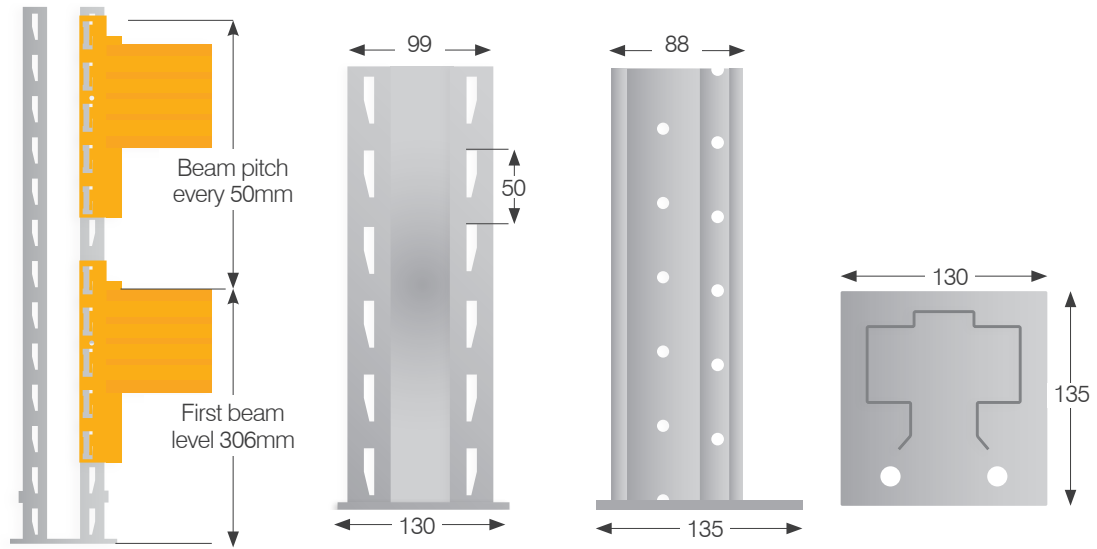

Frame capacity is calculated at a beam pitch of 1500mm, and a run of five 2700mm wide bays

ⓘ If you don't see a solution that meets your requirement, then please get in touch.

Now available in frames up to 6000mm high



Height	Levels	Shelf Load	Bay Load	Delivery
2500+ mm	2+ Shelves	2800+ kg	11000 kg [†]	5 days

Frames				
Depth - 900mm			Depth - 1100mm	
H (mm)	Code	Price	Code	Price
2500mm	MPRF/2509/GV	£117.30	MPRF/2511/GV	£122.70
3000mm	MPRF/3009/GV	£133.85	MPRF/3011/GV	£140.05
4000mm	MPRF/4009/GV	£163.75	MPRF/4011/GV	£170.65
5000mm	MPRF/5009/GV	£193.65	MPRF/5011/GV	£201.25
6000mm	MPRF/6009/GV	£231.65	MPRF/6011/GV	£241.50

Beams			
W (mm)	Code	Load Per pair (kg)	Price
1350mm	MPRB/1375/YW	3540	£53.60
2225mm	MPRB/2210/YW	2800	£89.10
2700mm	MPRB/2712/YW	3180	£115.60
3300mm (900mm depth)	MPRB/331709/YW	3790	£189.50
3300mm (1100mm depth)	MPRB/331711/YW	3790	£189.50

[†] Price includes uprights, metal feet and all necessary bracing, and fixings (including throughbolts).
[†] Frame capacity is calculated at a beam pitch of 1500mm, and a run of five 2700mm wide bays.



U-Shaped Upright Protector

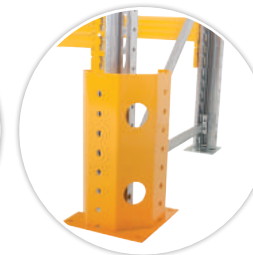

L-Shaped Upright Protector



Safety Pin

Accessories		
Description	Code	Price
Upright Protector Type L – 400mm	MPRUPL/04/YW	£52.20
Upright Protector Type U – 530mm	MPRUPU/05/YW	£37.70
200mm Row Spacer	MPPRS/20/GV	£3.75
250mm Row Spacer	MPPRS/25/GV	£4.35
Shim 1.0mm	MPR01/SHIM10	£1.25
Floor Fixing M12x100	FFM12x100	£1.55

i Need help designing your layout or costing a project, just give us a call.



Optimise your warehouse with Pallet Racking accessories

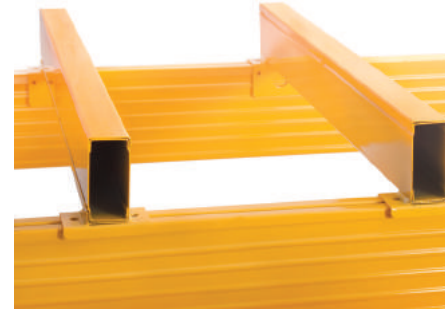

Fork Spacers

D (mm)	Load (kgs)	Code	Price
900 (Pair)	2000 (Pair)	MPRFS/09/YW	£58.40
1100 (Pair)	2000 (Pair)	MPRFS/11/YW	£65.00



Pallet Support Bars

D (mm)	Load (kgs)	Code	Price
900 (Pair)	1700 (Pair)	MPRSP/09/GV	£23.50
1100 (Pair)	1500 (Pair)	MPRSP/11/GV	£27.00

Wire Decking Panels

W x D (mm)	Load (kgs)	Code	Price
1350 x 900	1000	MPRMWD/1309	£29.00
2700 x 900	2000	MPRMWD/2709	£58.00
1350 x 1100	1000	MPRMWD/1311	£32.10
2225 x 1100	2000	MPRMWD/2211	£64.70
2700 x 1100	2000	MPRMWD/2711	£64.15
3300 x 1100	3000	MPRMWD/3311	£97.05

Open Timber Decking

W x D (mm)	Load (kgs)	Code	Price
1350 x 900	500	MPROTD/1309	£22.90
2225 x 900	810	MPROTD/2209	£40.95
2700 x 900	1000	MPROTD/2709	£45.80
3300 x 900	1226	MPROTD/3309	£61.45
1350 x 1100	685	MPROTD/1311	£28.35
2225 x 1100	1120	MPROTD/2211	£50.60
2700 x 1100	1375	MPROTD/2711	£56.70
3300 x 1100	1680	MPROTD/3311	£75.95

- ① Standard pallet loads are 1000kgs for minimum 800mm deep pallets on 900mm deep pallet racking
Standard pallet loads are 1000kgs for minimum 1000mm deep pallets on 1100mm deep pallet racking



① If you don't see a solution that meets your requirement, then please get in touch.

Choose your Pallet Racking Kit



900 Kits

For use with UK Pallets (1200 x 1000)

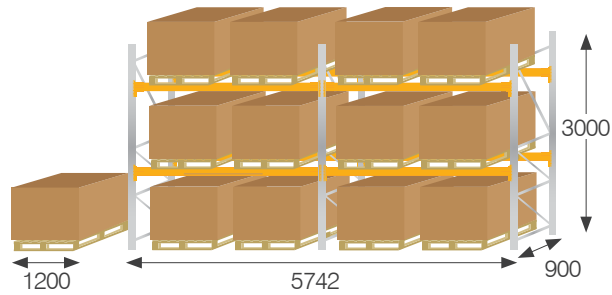

● Pallet Racking Kit 1 for 12 x pallets (Boxes shown H: 1000 x W: 1200mm)

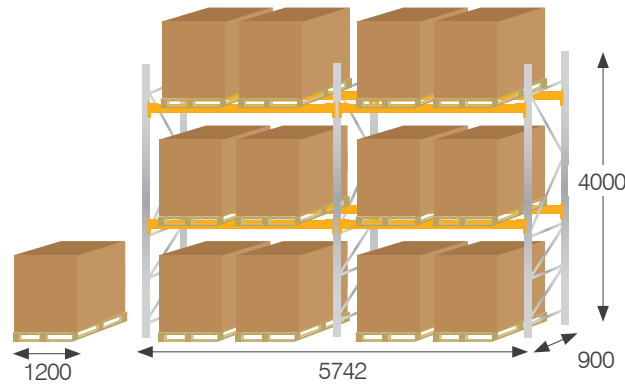

● Pallet Racking Kit 2 for 12 x pallets (Boxes shown H: 1500 x W: 1200mm)

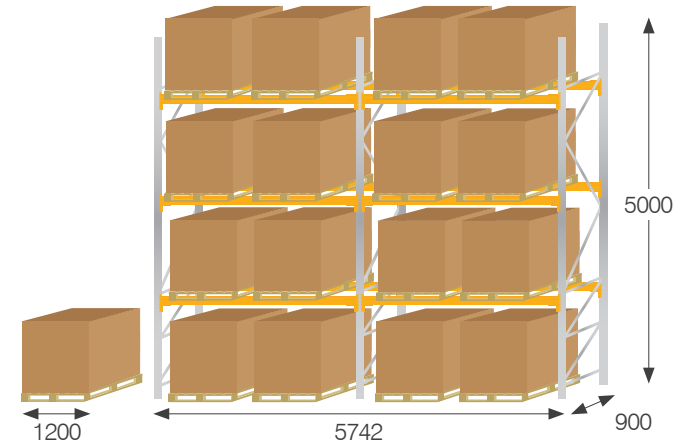

● Pallet Racking Kit 3 for 16 x pallets (Boxes shown H: 1200 x W: 1200mm)

Pallet Racking Kit 1

H x W x D (mm)	Code	Levels	Pallets Stored	Price
3000 x 5742 x 900	MPRK1	2	12	£774.75

Pallet Racking Kit 2

H x W x D (mm)	Code	Levels	Pallets Stored	Price
4000 x 5742 x 900	MPRK2	2	12	£864.45

Pallet Racking Kit 3

H x W x D (mm)	Code	Levels	Pallets Stored	Price
5000 x 5742 x 900	MPRK3	3	16	£1,132.35



1100 Kits

For use with Euro Pallets (800 x 1200)

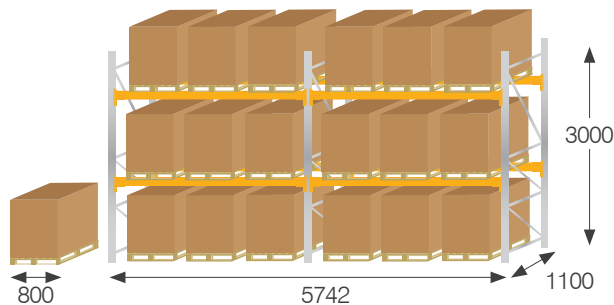

● Pallet Racking Kit 4 for 18 x pallets (Boxes shown H: 1000 x W: 800mm)

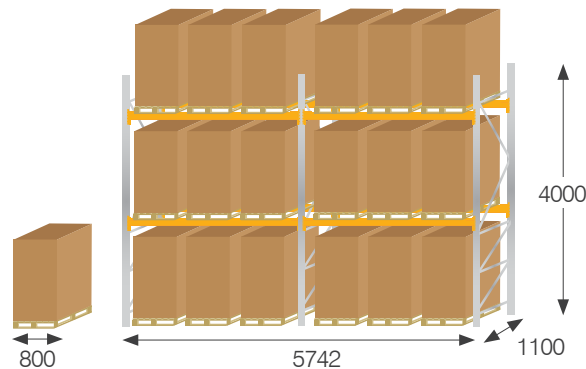

● Pallet Racking Kit 5 for 18 x pallets (Boxes shown H: 1500 x W: 800mm)

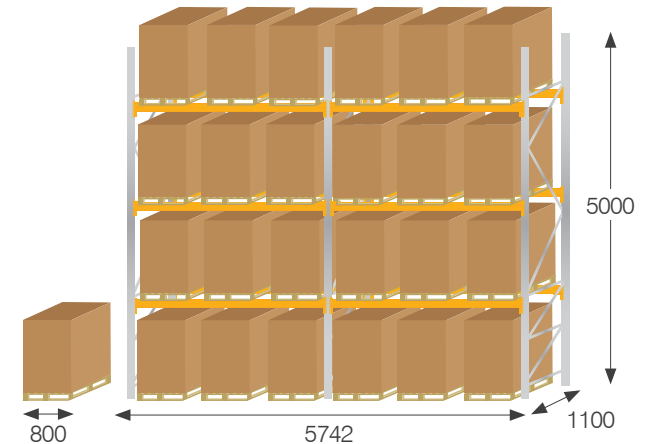

● Pallet Racking Kit 6 for 24 x pallets (Boxes shown H: 1200 x W: 800mm)

Pallet Racking Kit 4

H x W x D (mm)	Code	Levels	Pallets Stored	Price
3000 x 5742 x 1100	MPRK4	2	18	£793.35

Pallet Racking Kit 5

H x W x D (mm)	Code	Levels	Pallets Stored	Price
4000 x 5742 x 1100	MPRK5	2	18	£885.15

Pallet Racking Kit 6

H x W x D (mm)	Code	Levels	Pallets Stored	Price
5000 x 5742 x 1100	MPRK6	3	24	£1,155.15

① Each kit includes one starter bay and one extension bay. The beams are 2700mm long. Loading capacity is 3180kgs per level. Each kit includes frames, beams, locking pims, levelling shims and floor fixings.

① We offer other Pallet Racking configurations. Give us a call to see how we can accommodate your warehouse requirements.

